

digital audio

weiss engineering ltd.

Florastrasse 42, 8610 Uster, Switzerland

☎ +41 44 940 20 06 ☎ +41 44 940 22 14

🌐 <http://www.weiss.ch> / <http://www.weiss-highend.com>

WEISS



GAMBIT

DS1-MK3

OPERATING MANUAL

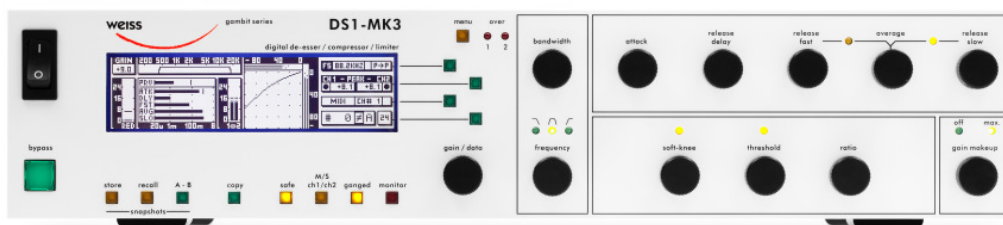

Software Version: 0S: 3.1,

DSP: 3.0

Release Date:

October, 2008

digital audio

weiss engineering ltd.

Florastrasse 42, 8610 Uster, Switzerland

☎ +41 44 940 20 06 📠 +41 44 940 22 14

🌐 <http://www.weiss.ch> / <http://www.weiss-highend.com>

WEISS



Authors: Andor Bariska, Daniel Weiss, Weiss Engineering LTD.

Weiss Engineering LTD. reserves the right to make changes to product specification or documentation without prior notice. Updated manuals and datasheets are available at our website for downloading. Weiss Engineering LTD. makes no warranty, representation or guarantee regarding the suitability of its products for any particular purpose, nor does part of this manual, and specifically disclaims any and all liability, including without limitation consequential or incidental damages.

All rights reserved. No part of this publication may be reproduced or transmitted in any form or by any means, electronic or mechanical including photocopying, scanning or any information storage or retrieval system without the express prior written consent of the publisher.

© Copyright Weiss Engineering LTD., 2008.

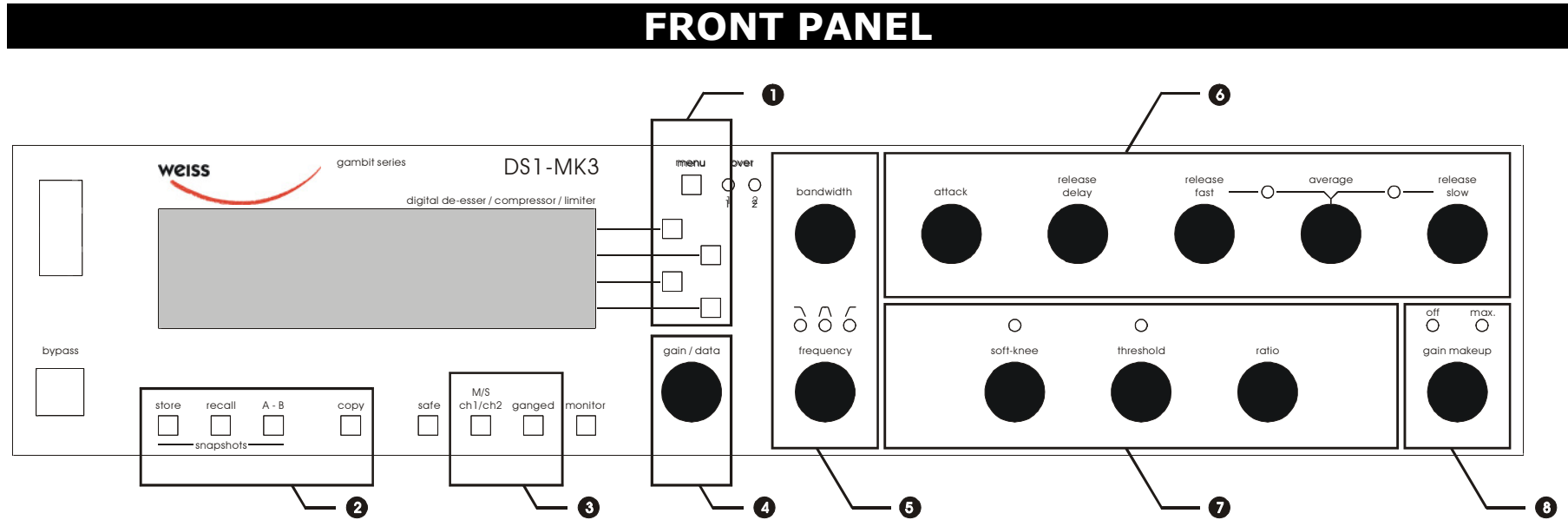

Graphic 1: Front Panel Elements

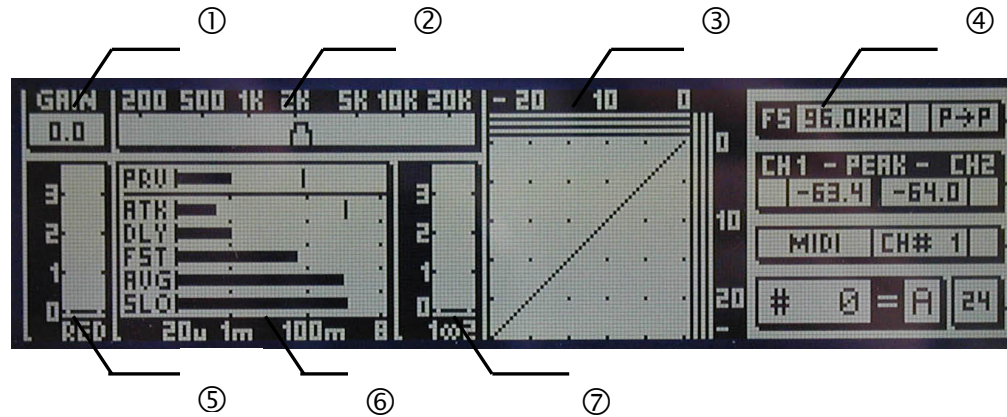

Graphic 2: Display Elements

Front Panel Groups

The front panel of the DS1-MK3 offers several control and display features.

Control

Refer to Graphic 1: Front Panel Elements

- | | | |
|-------|---|-------|
| ❶ | - Menu- and softkeys | p. 7 |
| ❷ | - Snapshot keys | p. 19 |
| ❸ | - ganged / channel select keys | p. 16 |
| ❹ | - Gain / Data controller | p. 8 |
| ❺ | - Crossover controllers | p. 12 |
| ❻ | - Envelope follower controllers | p. 10 |
| ❼ + ❽ | - Non-linear transfer curve controllers | p. 11 |

Display

Refer to Graphic 2: Display Elements

- | | | |
|---|---|-------|
| ❶ | - Gain value | p. 8 |
| ❷ | - Crossover setting (frequency selective mode only) | p. 12 |
| ❸ | - Non-linear transfer curve and signal metering | p. 11 |
| ❹ | - Status display | p. 7 |
| ❺ | - Peak limiter gain reduction meter | p. 8 |
| ❻ | - Envelope follower settings | p. 10 |
| ❼ | - Compressor gain reduction meters | p. 10 |

INTRODUCTION

Congratulations on purchasing the Weiss DS1-MK3 De-Esser / Compressor !

This two channel digital De-esser / Compressor features linear-phase crossover filters covering the whole audio band. Thus the DS1-MK3 is not just a De-esser but can also be used as band selective or full band Compressor / Limiter. The controls for the two channels can be ganged or ungangd (useful for M/S compression). Similarly, sidechain linking can be turned off.

Internal processing is either 88.2kHz (with 44.1 and 88.2kHz input) or 96kHz (with 48 or 96kHz input) in DeEsser and in Compressor mode. Double-precision up- and down-sampling units within the DS1-MK3 result in negligible distortion and high transparency for absolutely clean sound.

The non-linear segment can be adjusted from 1000:1 to 1:5, allowing every kind of dynamic processing, from limiting to upward expansion (for over-compressed signals). Put back a little dynamics into that ultra-finalized mix!

An additional safety-limiter takes care of any overs that are generated in DeEsser as well as in Compressor mode.

This and the ability to remote control parameters and snapshots makes the DS1-MK3 the perfect tool for the recording and mastering engineer!

Processing

- * 24bit digital input, internal 40bit floating-point arithmetic, dithered output for 16bit, 20bit or 24bit wordlengths.
- * Transparent phase-linear crossover for frequency selective compression
- * All parameters are immediately accessible with instant feedback through LEDs and the LC display.

Display

- * Standardised peak meters for compressor-stage in- and output with peak hold
- * Gain reduction meter with peak hold for compressor and for safety-limiter each.

- * Logarithmic graph of the transfer function of the de-esser/compressor calculated in real time
- * Status display showing sampling frequency, channel status data handling, current workspace and snapshot number and a resettable peak-hold and over-hold per channel
- * Parameter display (activated by touching the knobs) showing all timing, level and gain parameters
- * Signal status LEDs, showing OVERs, range of envelope signal and the status of the release time comparator

Snapshots

- * 3 x 128 non-volatile snapshots where all parameters are stored
- * A-B workspaces for quick comparison between two settings

Remote Control

- * Supports MIDI, RS-232 and RS-422 protocols
- * Standard MIDI Continuous Controllers for parameter remote control (including over-all gain)
- * Snapshot automatization with MIDI Program Change Commands
- * MIDI Dump of Snapshots

UPDATE HISTORY

Update from DS1 to DS1-MK2 v1.0 or v1.1

The main difference between these two versions is the ability of the DS1-MK2 to accept 88.2 / 96kHz input signals. Contrary to the DS1, where double sampling processing was only used in compressor mode, the DS1-MK2 now uses internal up- and downsampling stages and all processing is at 88.2 / 96 kHz.

There is a completely new feature available in the DS1-MK2, the upward expander. This is the logical extension of the compressor. Just turn the ratio controller counterclock wise to experience this new sound. New scale range on p. 26.

The DeEsser section has been enhanced with a new crossover, which covers the whole audio bandwidth (the DS1 used 271 Hz as lowest cut-off frequency, the DS1-MK2 can now be tuned down to 41 Hz). New scale range on p. 25.

And for those who like it hot, there is a new peak limiter section added in series to the compressor / de-esser, which cuts down spikes above 0.0dBFS. Read about its operation on p.8.

Update from DS1-MK2 v1.0 or v1.1 to DS1-MK2 v1.3

The main new enhancement is the parallel compressor option. To read about operating and options of the parallel compressor, turn to p. 14. This way of using a compressor was motivated by Bob Katz, here is what he says about it on the Mastering Webboard:

"You want a patch that compresses without stomping on the attacks at all, preserves transients but gives you great inner detail? ...

You have one control, one control only, and that is the output level of the compressor [gain makeup], the 'sidechain'. You can bring out inner details without losing breathing, and hardly affecting the upper dynamics at all. Works great. Not just great, absolutely fantastically. Fattens bass instruments without causing breathing or pumping. You name it, it works very well.

Variations: Use it like the Dolby Spectral Enhancer, by split band [parallel] compression, so

that (for example) high frequency inner details at low levels are enhanced. "

The other change in architecture is the addition of a second gain before the safety limiter, referred to as pre-limiter gain. The old overall gain is also still available. Read on p. 8.

Also, the scales of the gain, gain makeup and ratio parameters has been modified to suit customer feedback. New values on p. 26.

Update from DS1-MK2 v1.3 to DS1-MK2 v2.0

In the v2.0 version POW-R dithering capabilities have been added. The dithering menu now has a "setup" entry which gives you access to the three POW-R algorithms.

Update from DS1-MK2 v2.0 to DS1-MK2 v2.1

New Feature: Safety Limiter is now also of auto release type. No changes to the user interface.

Update from DS1-MK2 v2.x to DS1-MK3 (v3.0)

After several years of the DS1's use in mastering and recording studios world wide we have gathered and implemented a list of most wanted features suggested by our customers.

These include:

- Ganged or ungang control, i.e. independent parameters in L/R or M/S possible
- M/S or L/R processing
- Switchable sidechain link
- Continuously variable signal sensing from Peak to 800ms RMS

OPERATION

The following explanations assume that the de-esser/compressor is in power-up mode, i.e. no menu is active. If a menu is active, press the "menu" key repeatedly until the status display appears.

Status Display

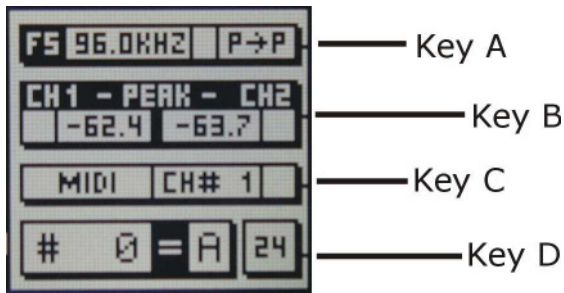

Graphic 3: Status Display

The status display consists of four groups displaying audio signal properties and information about the current state of the DS1-MK3.

Channel Status Group (Key A)

Situated adjacent to key A, displays the following information:

- * sampling frequency in kHz: "44.1", "48", "88.2" or "96".
- * pre-emphasis: "E" appears if pre-emphasis is set (empty if not used)
- * input → output channel status data format: "C" for consumer and "P" for professional

To change the output channel status data format, press key A and select format type or loop through.

Peak Group (Key B)

Situated adjacent to key B, this group contains a peak-hold and an over-hold for each channel. To reset these values press key B twice.

Peak-Hold

The numeric peak value is measured relative to 0dBFS (digital full scale).

Use this value to set the optimum gain for a specific session. Reset it for every session by pressing key B twice.

Over-Hold

Whenever an over is encountered, the boxes to the side of the peak-hold values are marked.

The functions of the over-LED's and the over-hold both depend on the NUMBER OF CONSECUTIVE OVER-SAMPLES setting. To adjust this setting, press key B once. Use the gain/data controller (4) to change the value, then press "menu" to return to the status display.

This setting defines the number of consecutive over-samples needed for an over-indication. To indicate every over-sample, enter 1. If another value is entered, you are still able to detect a single over-sample with the peak-hold function.

Over-samples are defined as exceeding the integer range. A full scale signal (0dBFS) will not be treated as over.

Remote Group (Key C)

Situated adjacent to key C, displays remote control protocol ("MIDI", "RS 232" or "RS 422"), channel ("1" - "16") and status (on/ off, displayed with check box).

For setup see chapter Remote Control (p.21).

Snapshot Display (Key D)

Bottom line in the status display. Refer to this for information on current workspace and snapshot. There are two workspaces ("A" and "B") for quick comparison of two de-esser/compressor settings. A workspace can be stored to a snapshot for later use.

The number of the last recalled snapshot will be displayed. If you change any value after the recall, the "=" will change to "≠" to symbolise that the workspace is not equal to the displayed snapshot anymore.

For snapshot handling see chapter Snapshots (p.19).

Dither Icon (Key D)

The dither icon is situated right next to key D (see Graphic 3). If dither is off, the icon contains the number "24", the word length of the output signal in bits. Turning dither on will produce arrows above and below the new word length number ("16" or "20"). Additionally, if auto-blackening is enabled, the bottom right corner of the icon is inverted.

For details on dither refer to chapter Dither (p. 18).

Gain / Output Gain

There are two gains, one pre safety-limiter and one post safety-limiter, as depicted in Graphic 4.

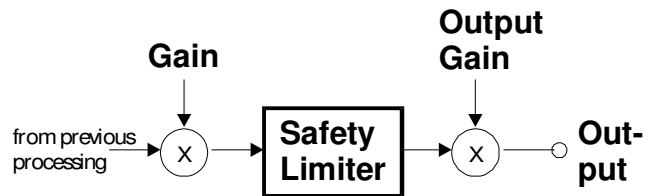

Graphic 4: Output section

When touching the gain controller (4), the required gain can be selected from a menu. To change the output gain, press softkey D. If an arrow appears inside the output gain window, the Output Gain can be adjusted. Press the D key again to control the pre-limiter gain which is shown in the upper left corner of the display.

Both gains are bypassed when Bypass is active.

The value shown in ① is the setting of the pre-limiter gain.

The post-limiter output gain should be used to set the maximum output level only (usually 0.0dB).

Safety Limiter

This feature is activated by pressing the "safe" key. When the "safe" key is lit, the limiter is on.

Safety limiter activity can be monitored with the second gain reduction meter below the "GAIN" window (①).

If the "safe" key is lit, overs will be limited by this fast peak limiter. The parameters of the limiter are fixed and cannot be adjusted.

However, the pre-limiter gain can be used to drive the safety limiter.

Too much pre-limiter gain will result in distortion!

Compressor Parameters

Following is a detailed description of all parameters that can be adjusted in the compressor stage. Guidelines are given for settings (see also the factory presets), but optimal settings are usually programme dependent, so experimenting and listening is inevitable for satisfying results.

Graphic 5 shows schematic and parameters of the DS1-MK3 compressor stage:

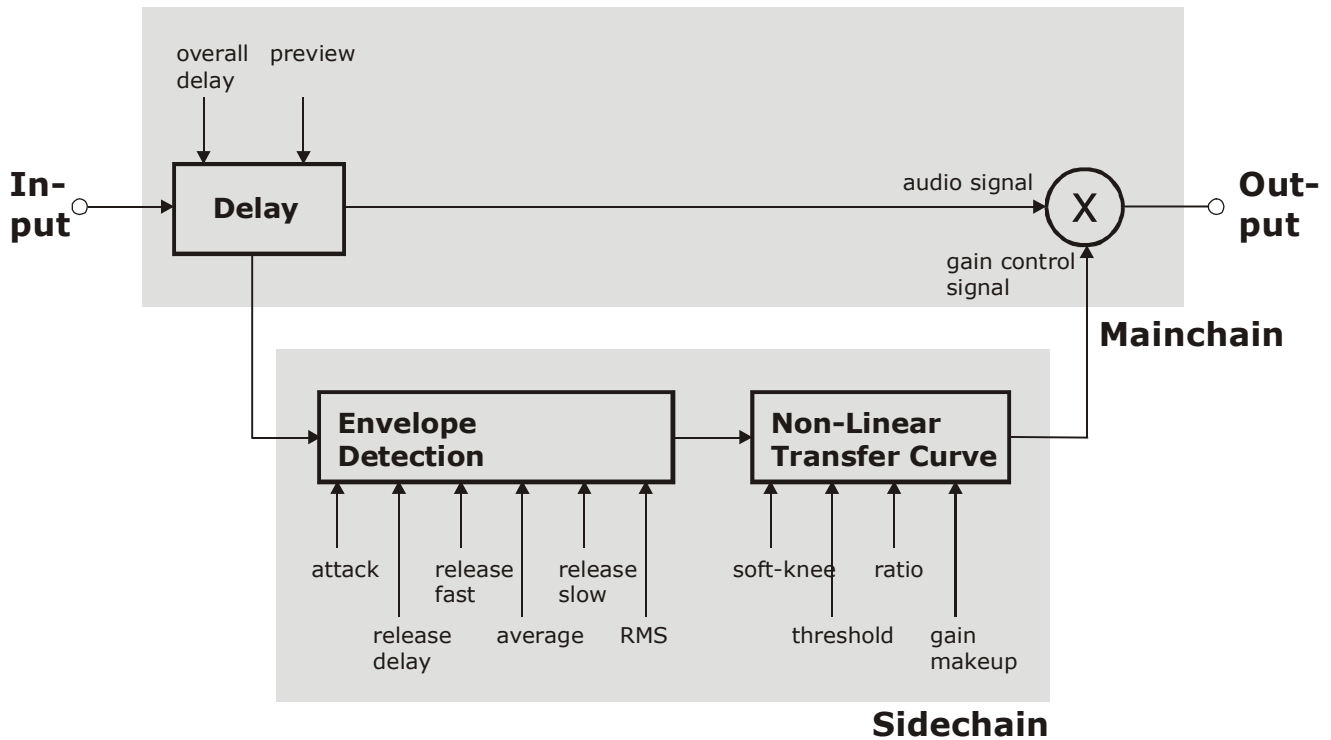

Graphic 5: Compressor schematic

Delay

A typical compressor/limiter circuit measures the audio signal and then generates the gain reduction control signal. At the time the control signal changes the gain, the programme material is already there, so the gain change occurs too late. The result is overshoot and possible subsequent distortion.

The DS1-MK3 uses a different method to generate the gain control signal: The audio passing through the mainchain is delayed by a fixed amount of time, determined by the „overall delay“. By branching the signal out of the delay line, the sidechain „sees“ the signal before it reaches the output, thus allowing look-ahead compared to the mainchain. The resulting corrected output signal has no overshoots, no leading edge distortion or other side effects due to timing lags in the sidechain.

The preview (the time the signal reaches the sidechain ahead of the multiplier) cannot, of course, exceed the overall delay.

The overall delay is the sum of the maximum overall delay („Delay“ box in Graphic 5) and the delay required for other signal processing (linear-phase filtering for up- and downsamplers). Any snapshot value of the preview delay which exceeds this maximum, is clipped to the maximum, because the overall delay is not stored in the snapshots and therefore the preview delay in any snapshot can exceed the currently selected overall delay.

Setting overall delay: The overall delay is adjusted by pressing the „menu“ key (1) then selecting the „system“ and then the „overall delay“ option. Use the gain / data controller (4) to change the delay value. Maximum consequential preview time and delay in frames is also displayed. Please note that during delay

change, audio is muted to avoid audio signal cuts.

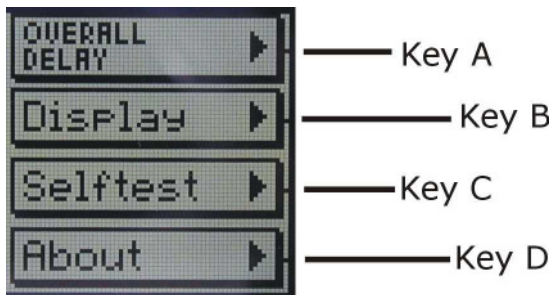

Graphic 6: System menu

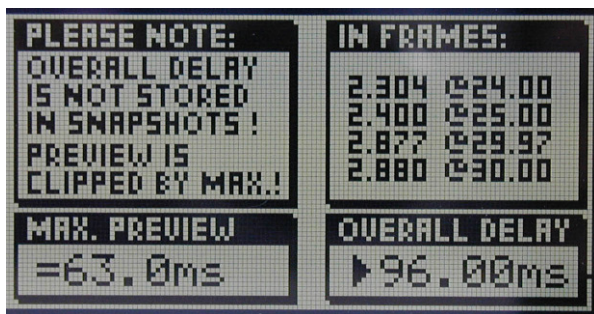

Graphic 7: Overall Delay display

Setting preview: Touch either the „attack“ or „release delay“ controller (6) to activate the timing 1 window, then use the gain / data controller (4) to adjust preview time.



Graphic 8: Timing 1 window

Envelope Follower

The envelope follower parameter controllers are in area 6. The purpose of the envelope follower is to cause gradual gain changes, thus eliminating distortion. The current values are shown in 6.

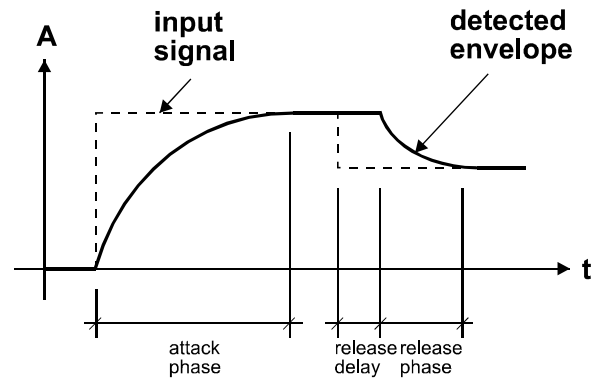

Graphic 9: Envelope Parameters

Attack and Preview: The longer the attack time, the more will the leading edge of fast transients pass by the gain reduction circuit unaltered (as in Graphic 9 during attack phase). Very fast attack time settings such as 20µs, i.e. one sample period, do catch every transient, but may distort low frequencies. To utilise longer attack times and still catch fast transients, use preview.

Release and Average: The input signal is monitored with two different methods: peak amplitude (*) and RMS value. The peak amplitude is the programme portion we don't perceive as very loud, however which can easily cause overloads. The RMS value of the programme material we perceive as loudness. Its variations contribute most to the dynamic range of the audio.

The sidechain processor compares the two measurements it obtained from the peaks and the RMS. The ratio between the two determines which time constant would be the appropriate release, e.g. after short duration peak the faster release will be applied during the release phase.

The time period over which the RMS value of the programme material is averaged is set by the "average" parameter. The effect of the average parameter can best be studied on the gain reduction meter (7). Fast "average" settings will cause most of the gain reduction meter to move very fast (depending on the "release fast" setting), slower settings will just have the top part of the gain reduction move fast, with the bottom part depending on the "release slow" setting.

(*) **Peak / RMS:** In the DS1-MK3 the peak measurement is supplemented with an RMS measurement with variable averaging time. To access the RMS detection timeconstant touch the gain / data controller (4) which opens this window:



Graphic 10: Gain / Data Knob menu

Hit Key B to assign the gain / data knob to the RMS detection time constant. The left endstop of this parameter switches the detection to peak mode, as used in all previous DS1 versions.

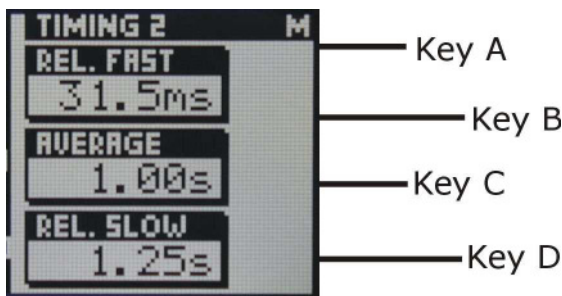

Graphic 11: Timing 2 window

Release Delay: Normally the release phase begins immediately after the programme material has fallen in level. The release delay determines how long the DS1-MK3 holds the current level before entering release (see Graphic 9).

The resulting dynamic characteristic is very smooth and avoids otherwise typical 'pumping' effects. The ideal setting is programme dependent and experimentation may be necessary to achieve the best combination of all dynamic parameters.

Non-Linear Transfer Curve

The transfer curve parameter controllers are in area 7 + 8. This part of the sidechain is responsible for the actual gain reduction (7) calculations. The detected signal envelope is com-

pared with the transfer curve, the gain control signal (see Graphic 5) is then adjusted accordingly if the envelope overshoots the transfer curve.

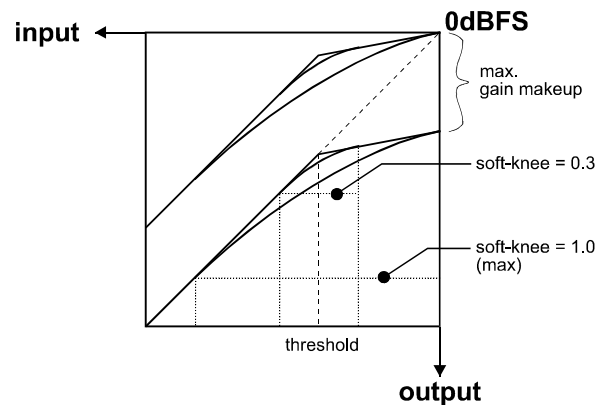

Graphic 12: Transfer Curve Parameters

Threshold: Sets the level which the envelope signal has to reach before gain reduction is applied.

Ratio: Sets the slope of the segment above the threshold. The ratio can be adjusted for compression or expansion, depending on the requirement. For full band expansion (e.g. to reintroduce dynamics into an over-compressed signal), one will usually work with the gain makeup set to maximum. This means that a 0.0dB input will be passed through without gain, signals below the threshold will be reduced with a constant gain (depending on threshold and ratio setting, can be read from the display when touching the gain makeup controller), and signals between the threshold and 0.0dBFS get expanded. For full band expansion, one will typically have quite high thresholds (-1dB ... -4dB), because of the resulting overall gain.

The expander can also be used in frequency selective mode, for example to repair the effect of a misused multi-band compressor – for this purpose, the gain makeup can be set higher than the calculated maximum setting, to compensate for the overall gain that the expander causes. This can potentially cause overs (for loud signals in the expanded band), it is therefore good practice to engage the safety limiter (see below).

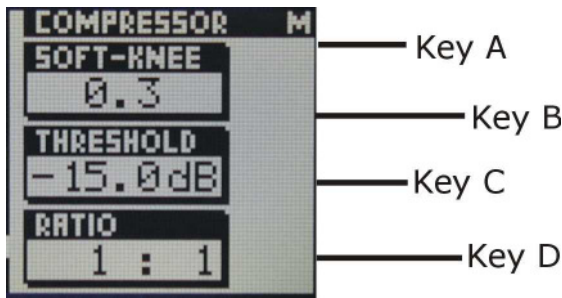

Graphic 13: Threshold, Ratio, Softknee

The expander can only amplify gain differences. This means that it cannot create a dynamic signal if there was no initial gain difference (as is the case in computer generated music or with extremely hard-limited mixes).

Soft-knee: Determines how much the knee is rounded. The maximum setting (1.0) chooses a curve that reaches from 0dBFS down to twice the threshold value. This implies that if soft-knee is engaged the signal is already affected even if its envelope lies below the threshold.

Gain makeup ③: Moves the whole transfer curve up or down. In de-essing mode the gain makeup is usually set between the minimum (-10dB gain) and "off" (0dB gain) to actually attenuate the processed signal, while in compressor (full band) mode the transfer curve usually gets to lie anywhere between "off" and "max", according to the amount of loudness correction one wants to apply.

Once "max." is on, the transfer curve is attached to 0dBFS for maximum possible gain. "max" is engaged as soon as the curve reaches 0dBFS by manipulating any combination of the above parameters, or by selecting "max" from the gain makeup menu. This mode can be exited by manually reducing the gain makeup or by selecting "off" from the gain makeup menu.

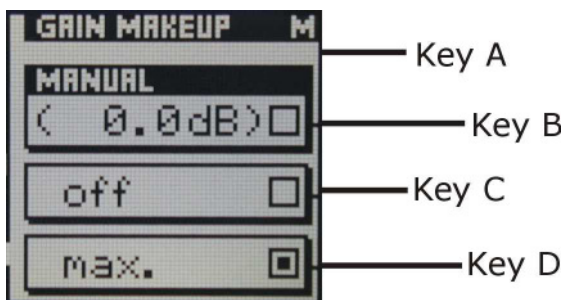

Graphic 14: Gain Makeup display

The applied gain reduction from the compressor section is displayed in ⑦.

Signal Meters: The meters in ③ show the level of the input (horizontally on top of the transfer curve graph) and output of the compressor stage (vertically to the right of the transfer curve). Refer to Graphic 16 and 17 to see the metering points.

Band Selective Mode vs. Full Range Mode

The DS1-MK3 can be used in conjunction with a frequency crossover (band selective mode) or straight (full range mode).

How to change modes: Touch the centre frequency or bandwidth controller (⑤). The soft-keys become selection keys for the filter type: highpass (Key A), bandpass (Key B), lowpass (Key C) or bypass (Key D). In bypass the full range mode (compressor) is selected. Any other filter type engages the appropriate filter ahead of the compressor stage.

Band Selective Mode (Graphic 16): In this mode, a frequency crossover is put into the signal path, splitting it up into two or three bands, depending on the filter type setting. One of the bands is compressed, the other is delayed by the same amount used as „delay“ in the compressor stage. This mode is completely transparent if no gain reduction is applied.

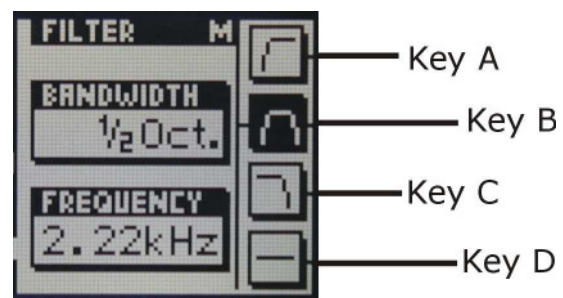

Graphic 15: Band Filter menu

Note, the input and output meters on the transfer graph (③) are connected after the crossover and before the adder.

Full Range Mode (Graphic 17): In this mode the compressor input meter is at the input of the DS1-MK3. The crossover controllers and the monitor key have no function.

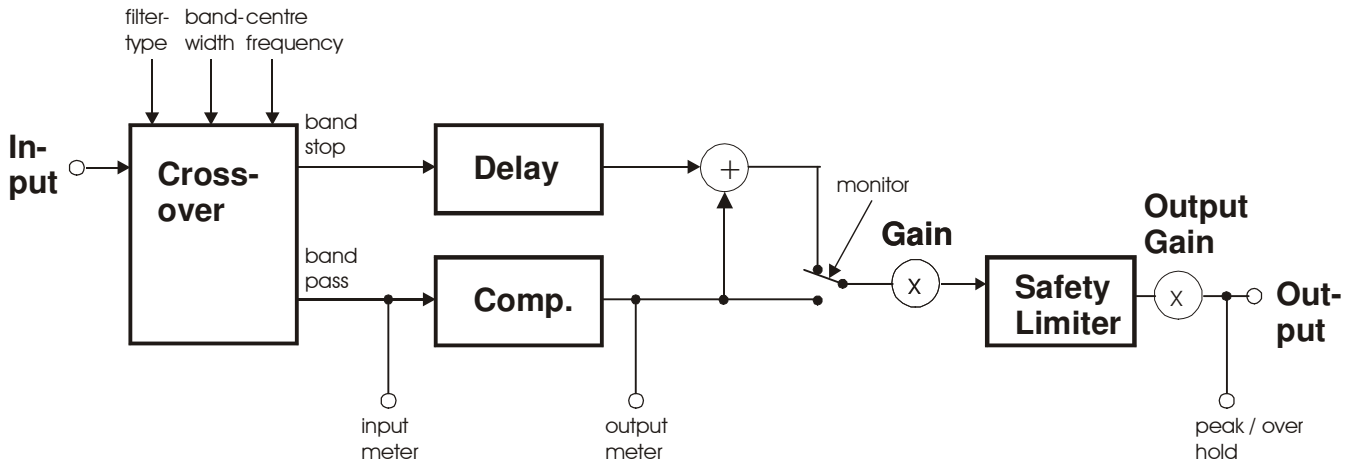

Graphic 16: Band Selective Mode

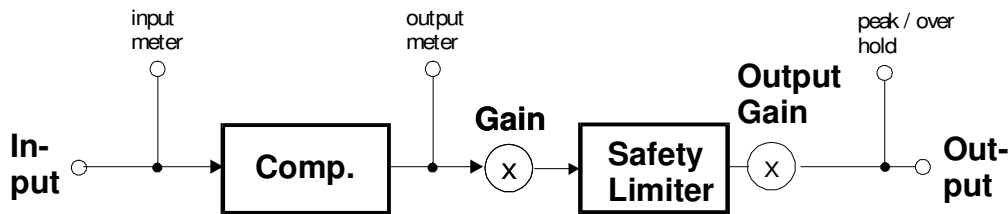

Graphic 17: Full Range Mode

Parallel Compressor

The DS1-MK3 can be used in parallel compression mode, where the compressed signal is added to the straight signal.

How to activate parallel compression: Touch the gain / data controller (4). In the menu that appears, mark the checkbox with softkey A. When using parallel compression, the DS1-MK3 is able to run in frequency selective or in full band mode.

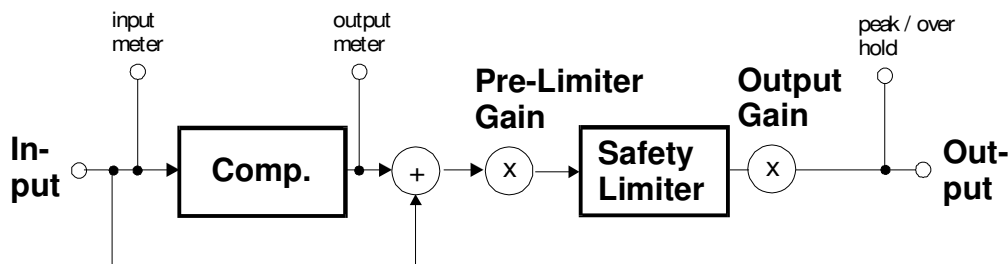

Graphic 18: Parallel Full Range Compression

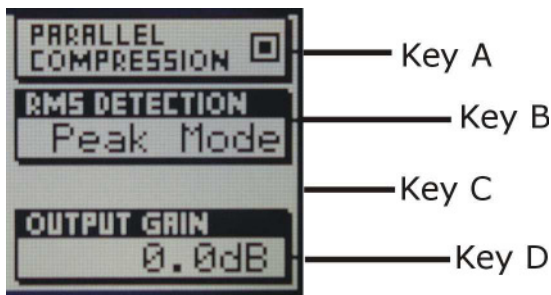

Graphic 19: Parallel Compression on/off (Key A)

Parallel full band compression: As can be seen in (Graphic 18), the input signal and the compressed signal are summed. The gain makeup value can be used to control the amount of compressed signal. The pre-limiter gain can be used to scale the mix before limit-

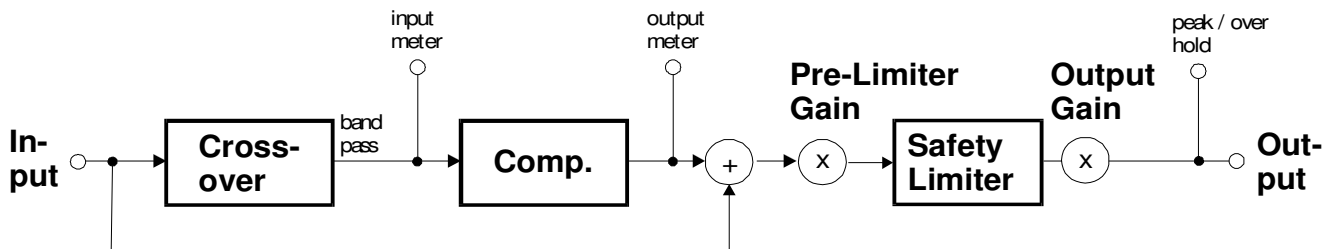

ing.

Parallel band selective compression

(Graphic 20): To add even more subtle compression, the compressed signal can be filtered before compression. Using the monitor function, one can listen to the filtered signal for optimal crossover setup.

Why parallel compression?

Read this quote from Bob Katz from the Mastering Webboard:

“You want a patch that compresses without

stomping on the attacks at all, preserves transients but gives you great inner detail? ...

You have one control, one control only, and that is the output level of the compressor [gain makeup], the ‘sidechain’. You can bring out inner details without losing breathing, and hardly affecting the upper dynamics at all. Works great. Not just great, absolutely fantastically. Fattens bass instruments without causing breathing or pumping. You name it, it works very well. Variations: Use it like the Dolby Spectral Enhancer, by split band [i.e. parallel] compression, so that (for example) high frequency inner details at low levels are enhanced.”

This last paragraph refers to parallel band selective compression (crossover in highpass mode).

Graphic 20: Parallel band selective compression

Starting point for parallel compression:

Set the threshold for -50 dBFS, ratio to 2.5:1, attack to the fastest (microseconds), release to mid, around 250-300 ms (adjust to taste if you hear breathing or pumping). The makeup gain governs the amount of compression.

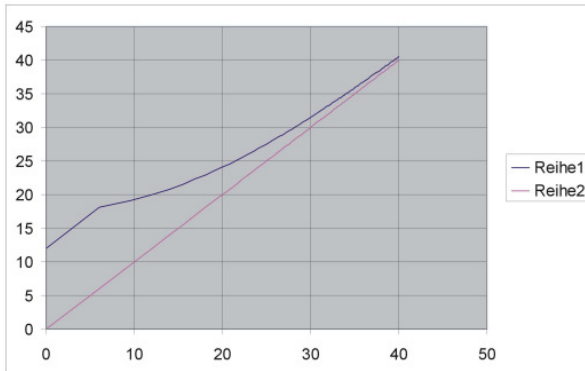

Graphic 21: effect of parallel compression

Graphic 21 shows the effect of Parallel Compression on the transfer curve (upper graph). Lower levels are raised while higher levels are not much affected.

Ganged / Unganged

The DS1-MK3 allows for independent parameter settings in channels 1 and 2 (ⓐ). If the ganged key is lit, both channels operate with the same parameter set.

If the ganged key is not lit, the two channels can operate with different parameters. The CH1/CH2 / M/S key assigns the knobs and the display to the appropriate channel, i.e. key not lit assigns CH1 or M and key lit assigns CH2 or S. In ganged mode the CH1/CH2 M/S key can be used as a A/B key in that either CH1 settings are applied to both channels or the CH2 settings are applied to both channels.

The copy menu (copy key) allows to copy CH1 into CH2 parameters or vice versa in order to have the same parameters in the two channels to start with.

M/S Mode, Sidechain Link

The DS1-MK3 can be switched to M/S (Mid / Side) mode. To do that press the menu key, the following menu opens up:

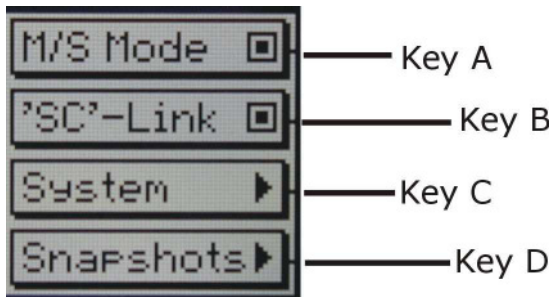

Graphic 22: M/S Mode and Sidechain Link

Key A selects M/S Mode on / off (box checked means M/S mode engaged) while Key B selects the sidechain link on / off (box checked means sidechain linked). In M/S mode it usually is preferable to set the channels unged and the sidechain unlinked.

Graphic 23 shows the block digram of the DS1-MK3 when in M/S mode. Note the positions of the M/S encoder and decoder. With the "Gain" controls it is possible to change the balance between M and S, while the "Output Gain" controls are arranged after the M/S to L/R conversion.

The "Compressor" block can again work in full band mode or in band selective mode, inde-

pendently in the two channels. I.e. it is possible to process e.g. the S signal in full band mode and have the M signal processed in band selective mode for de-essing.

The parallel compression again works around the "Compressor" block. Parallel compression can be switched on independently in the two channels.

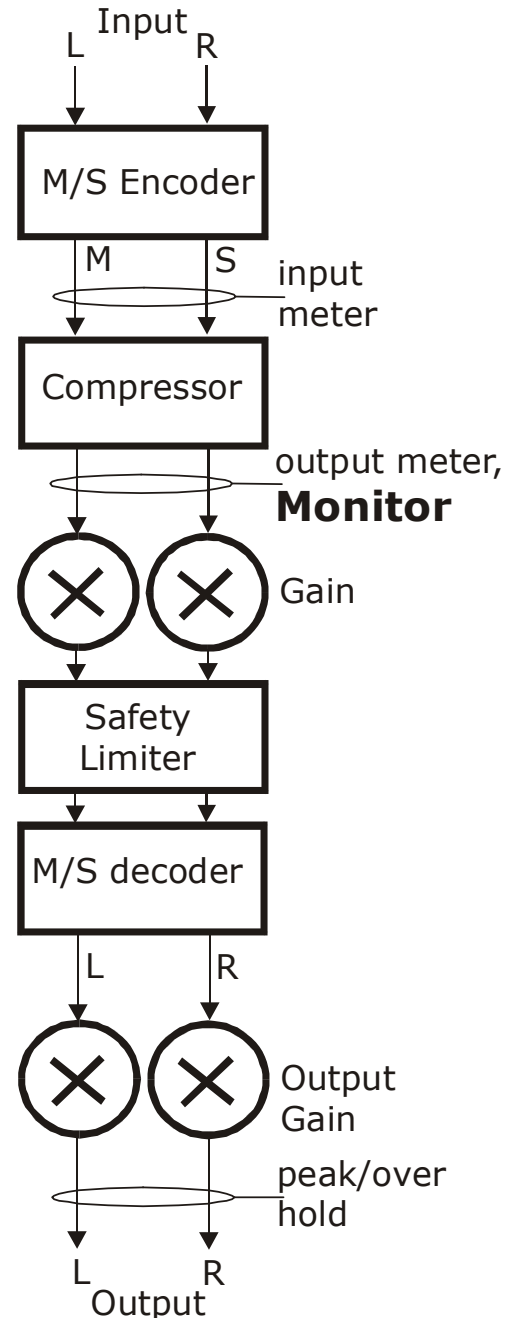

Graphic 23: Block diagram in M/S mode

Monitor Key

In band selective mode pressing the “monitor” key allows you to listen directly to the processed band, ideal for zooming in on offending material and listening to the effect of the compressor stage.

See Graphic 23 above for the **Monitor** output position.

The Monitor output works as follows:

DS1-MK3 in ganged mode:

The stereo signal is fed forward to the output. If the band selective mode is selected, only the active band is fed to the output.

DS1-MK3 in unganged mode:

The currently selected channel (CH1 or CH2 or M or S) is fed to both L and R outputs. This allows for instance to listen to the S signal only in order to adjust the compressor optimally.

If monitor is active, the output peak hold and the over detection run on the monitor signal, not on the main output.

Factory Presets

The DS1-MK3 has easily accessible factory presets for a quick setup which can then be refined and adapted to the programme being processed. These factory presets are grouped according to their creators:

The first few factory presets we created at Weiss Engineering, then a whole bunch of presets created by Bob Katz follow. Bob's presets come with a detailed on-screen description. Note that most of Bob's presets need a threshold and/or a ratio dialed in in order to work.

We invite users of the DS1-MK3 to supply their favourite presets for adding them to the list.

To access the factory presets press the "menu" key then "snapshots" and then the "presets" key.

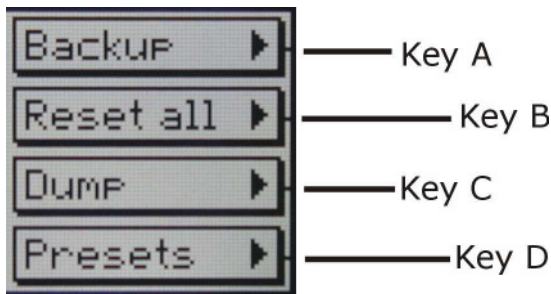

Graphic 24: Snapshots menu

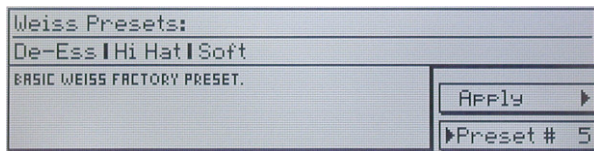

Graphic 25a: Example of a factory preset menu

The appropriate preset # is selected with the Gain / Data rotary encoder. Pressing the "Apply" key loads the preset without leaving the preset menu. All rotary encoder controls are active in the background, thus a preset can be loaded via the "Apply" key and then modified with the rotary encoders to check whether the preset fits the requirements.

Pressing the "Preset #" key loads the preset and exits the Factory Preset menu.

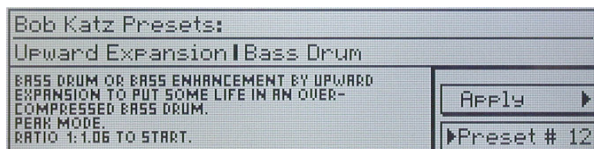

Graphic 26b: Another example of a factory preset menu

Dither

The DS1-MK3 is able to apply POW-R type dither algorithms to avoid distortion when re-quantizing from 24bit to 16bit or 20bit output word length (see TECHNICAL DATA for dither specifications).

To toggle dither on/off, press key D twice. To see dither status refer to the status display (④, see Status Display p. 7).

Word Length

To set output word length, press key D and select the appropriate wordlength.

Setup

Press key D then chose the setup menu. This leads to the menu where the type of POW-R dither can be chosen (see TECHNICAL DATA for dither specifications). Also selectable is:

Auto-Blacking

If auto-blacking is activated by marking the "0 IN → 0 OUT" option, dither will be turned off if the input signal is zero. As soon as the input signal changes, dither will be turned on again. This ensures that pauses between programmes are still digital zero, even if dither is activated.

Snapshots

Snapshots are copies of the DS1-MK3 parameter settings. This allows recalling complete setups including all parameters and controls settings. Snapshots can be recalled from the front panel or by remote control (e.g. MIDI Program Change).

Snapshot access keys are in ②. To see workspace status refer to the status display (④, see Status Display p. 7).

A-B Comparison

You can compare two settings by using the two workspaces "A" and "B". To toggle between the two press the "A-B" key. Restore a snapshot or simply adjust parameters in one workspace, then switch to the other to compare.

To copy workspace "A" to "B" or vice versa, press the "copy" key and select an option (Graphic 25).

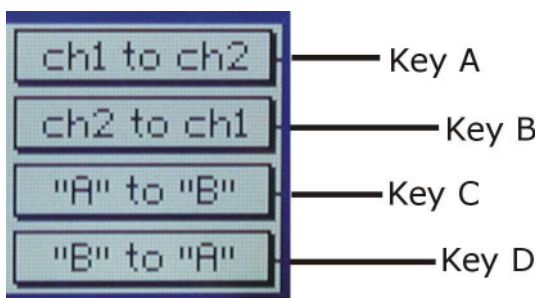

Graphic 27: Copy menu

The active workspace is shown in the status display.

Recall Snapshots

To recall a snapshot press the "recall" key. Notice that the snapshot will be copied into the active workspace. If you do not want to lose these settings, switch to the other workspace by pressing the "A-B" key.

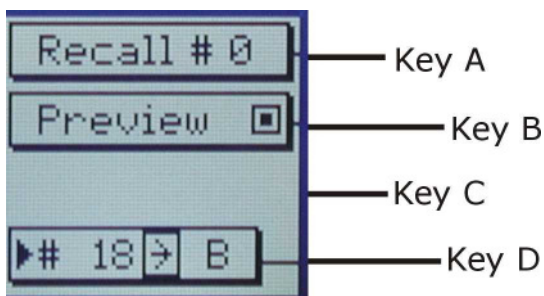

Graphic 28: Recall menu

Using the gain/ data controller (④) enter the number of the snapshot you want to recall. The graph of the snapshot will be displayed. However, the audio signal is not affected if the "Preview" option is marked. Once you have found the snapshot, press key D to restore it.

If the "Preview" option is not marked, the snapshots will be recalled as soon as you enter a new number.

Press the "recall" key to return to the status display.

"Recall # 0"

Snapshot 0 can be used for a quick reset.

Store Snapshots

To store the current workspace to a snapshot, press the "store" key. With the gain/ data controller (④) enter the snapshot number where you want to store the workspace, then press key D. Snapshots can be prevented from accidental erasure by marking the "Safe" option. A setting can be stored to multiple snapshots. Press "To Range" in the "store" menu.

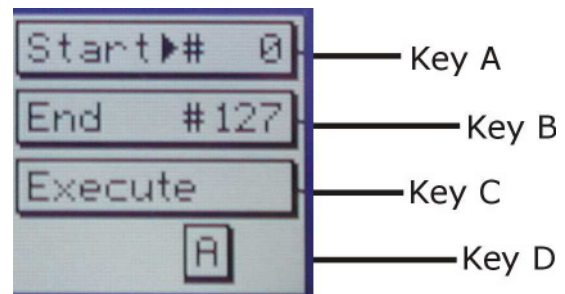

Graphic 29: Store To Range menu

Press the adjacent keys to select "Start" and "End" snapshot number, use the "gain/ data" encoder to enter a value (Graphic 27). Pressing "Execute" will store the setting from the displayed workspace ("A" or "B") to all snapshots between the Start and End value. A "Safe" snapshot will not be overwritten.

Backup Snapshots

All 128 snapshots can be transferred to another internal non-volatile memory area for later reference. There is enough memory for two complete snapshot sets to be backed up.

Press the "menu" key (①) then choose the

"Snapshots" and then the "Backup" option to arrive at the backup display (Graphic 28).

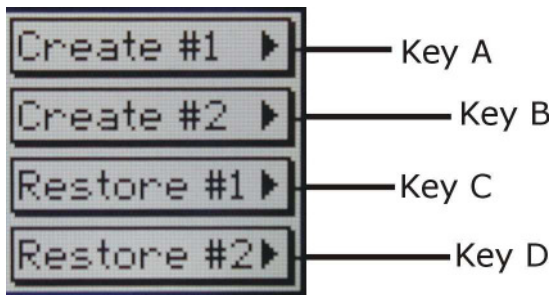

Graphic 30: Backup display

Select "Create #1" to save the current snapshots to bank 1. Select "Restore #1" to overwrite the current snapshots with bank 1 (ditto for bank 2).

A backup will overwrite "safe" snapshots.

Reset all Snapshots

To reinstall the factory snapshots press the "menu" key then "snapshots" and then the "Reset all" option. This will reset the current snapshots. The snapshots that have been backed up are preserved.

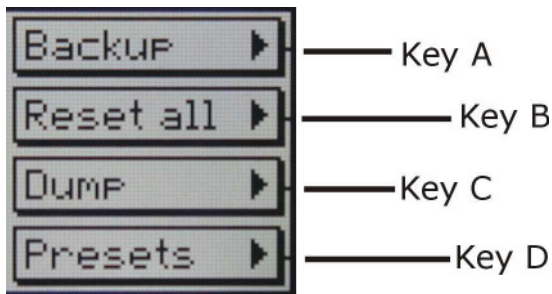

Graphic 31: Snapshots menu

Dump Snapshots

The settings of all 128 snapshots can be dumped to a remote control port to be stored externally. Please make sure that you have connected everything correctly and that the proper remote control port is activated (see chapter Remote Control for setup).

When dumping to a MIDI-sequencer, make sure that the sequencer is not sending or receiving data other than the snapshot dump.

Certain sequencers are not capable of handling the amount of data output by the DS1-MK3 and might crash during or after the dump process.

To initiate a dump, press the "menu" key then choose the "Snapshot" and then the "Dump" option. Start the recording process on the sequencer, then press "Transmit". This releases the dump to the sequencer.

Loading Snapshots

To load a snapshot dump from sequencer, simply play the dump sequence. The DS1-MK3 will automatically switch into receive mode and display statistics about the snapshots it's receiving. If the transmission was OK, the program switches back to normal mode. Upon error, you have to manually switch back to normal mode.

Snapshots made with the MK2 version can be reloaded into the MK3 unit as well.

When playing back the dump sequence, always use the same speed as when the sequence was recorded.

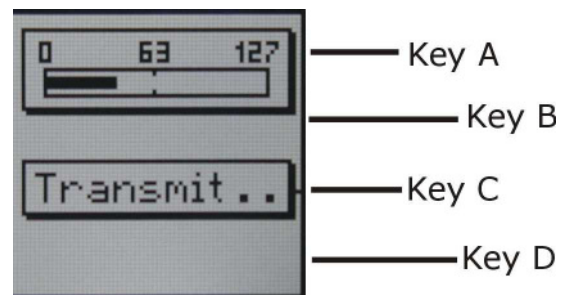

Graphic 32: Dumping Snapshots

Meter Resolution

The transfer graph and the compressor peak meters (③) work with different resolutions to accommodate signals with a wide dynamic range.

The resolution for the peak meters and transfer graph can be set in fixed steps of -20dB, -40dB and -80dB, or alternatively, to auto. In auto mode, the display switches to the next step as soon as the transfer graph falls below the current window. The peak meters resolution is always the same as the transfer graph's.

The same principle applies to the gain reduction meters of the compressor (⑦) and the safety limiter (⑤).

To adjust gain reduction or peak meter resolu-

tion, press the „menu“ key (1), then chose „system“ and then press the „display“ softkey. Then use keys A and B to select either „gain reduction“ or „curve“ to change the resolution of the corresponding graphs. Use the gain / data controller (4) to alter values.

LCD Contrast

To change the display contrast, press the „menu“ key (1), then „system, then „display“. Press key D to activate „LCD Contrast“. Adjust contrast with the gain / data encoder.

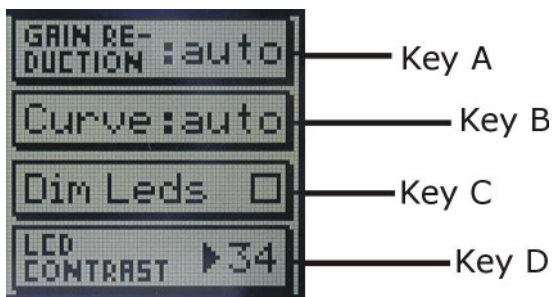

Graphic 33: Display menu

Bypass

The DS1-MK3 can be completely bypassed with the green „bypass“ key below the mains switch. If the „bypass“ key is lit, the DS1-MK3 is absolutely transparent, making the output signal bit equal to the input signal. However, the overall delay (see chapter Delay) is still active.

While bypass is active (key is lit), the DS1-MK3 works in preview mode. This allows you to change parameters without actually affecting the audio signal.

Remote Control

All band parameters as well as control settings can be set externally.

To see remote control status refer to the status display (4, see Status Display p. 7).

Protocol

To select a remote control protocol, press key C from the status display menu. Select either „RS 232“, „RS 422“ or „MIDI“. This will determine which port at the rear of the DS1-MK3 is active. The other inactive ports will be ignored.

Press the „menu“ key to return to the status display if you do not want to change remote on/off status.

When selecting a port other than MIDI you have to specify the baud rate. Refer to the remote control software manual for correct settings. The set baud rate is displayed to ensure proper set-up.

Channel

To change the remote control channel number, press key C (adjacent to the remote control field). Use the gain / data controller (4) to select a value between 1 and 16. Press the „menu“ key to return to the status display. Omni mode (listening on all channels simultaneously) is not supported.

On/ Off

To enable or disable remote control, press key C (adjacent to the remote control field). Press it again to toggle the „ON/ OFF“-value.

While remote control is off, data will still be sent to the selected port. Also, the MIDI THRU output will always mirror the MIDI IN input data regardless of „ON/ OFF“ or protocol status.

Software Information

Press the "menu" key (ⓘ), then select the "System" and the "About" option. This displays a screen with all the relevant information on your DS1-MK3 and how to reach us. Have this page ready when you want to report a problem.

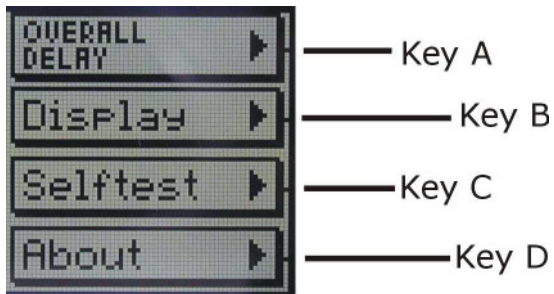

Graphic 34: System menu



Graphic 35: About screen

TECHNICAL DATA

AES/EBU Input

Sampling Frequencies:	44.1 kHz, 48.0 kHz, 88.2 kHz or 96kHz
Maximum Input Wordlength:	24 Bits
Channel Status Data:	Input accepts professional or consumer format.
Channel Status Bits forwarded to AES/EBU output:	see table below
Connector:	XLR female

AES/EBU Output

Sampling Frequencies:	44.1 kHz, 48.0 kHz, 88.2 kHz or 96kHz
Output Wordlength:	24 Bits
Connector:	XLR male

AES/EBU Channel Status Data

The DS1-MK3 allows to convert the incoming Channel Status Data as follows:

- * From Consumer to Professional
- * From Professional to Consumer
- * Transparent mode, i.e. Channel Status Data is fed forward to the output without any conversion (one exception, see below)

The following tables describe how the Channel Status Data bits are generated in the various conversion modes.

Output selected: Consumer format.

Input: Consumer format.

Output: All bits fed forward (transparent), except for:
 Byte 1: Bits 0..6: 0000000 (category code general)
 Bit 7: 1 (original)

Input: Professional format.

Output:
 Byte 0: Bit 0: 0 (consumer)
 Bit 1: 0 (audio)
 Bit 2: 1 (copy allowed)
 Bits 3,4: Preemphasis according to input
 Bit 5: 0 (2 channel mode)
 Bits 6,7: 00 (Mode 0)

Byte 1: Bits 0..6: 0000000 (category code general)
 Bit 7: 1 (original)

Byte 2: Bits 0,1,2,3: Sampling Frequency according to input
 Bits 4,5: 00 (accuracy grade II)
Bits 6,7: 00

Bytes 3..23: reserved bytes

Output selected: Professional format.

Input: Professional format.

Output: All bits fed forward (transparent), except for:

Byte 2: Bits 0,1,2: 001 (max. sample length= 24bit)
Bits 3,4,5: 101 (24 bit word length)
Bits 6,7: 00

Input: Consumer format.

Output:

Byte 0: Bit 0: 1 (professional)
Bit 1: 0 (audio)
Bits 2,3,4: Preemphasis according to input
Bit 5: 0 (source fs locked)
Bits 6,7: Sampling Frequency according to input

Byte 1: Bits 0,1,2,3: 0001 (two channel mode)
Bits 4,5,6,7: 0000 (no user bit encoding)

Byte 2: Bits 0,1,2: 001 (max. sample length= 24bit)
Bits 3,4,5: 101 (24 bit word length)
Bits 6,7: 00

Bytes 3..12: All bits 0

Byte 23: CRCC byte

Output selected: Transparent.

Input: Any format.

Output: All bits fed forward (transparent), except if not bypassed:

Byte 2: Bits 0,1,2: 001 (max. sample length= 24bit)
Bits 3,4,5: 101 (24 bit word length)
Bits 6,7: 00

Power

Mains Voltage: 110 / 220 Volts with voltage selector
 Fuse rating: 500 mA slow blow
 Power Consumption: 40VA max

Overload

Number of consecutive over-samples to cause "over" display: 1..16 settable

Peak Meters

Peak meters timing for compressor input and output stage adhere to AES recommendations.

Parameter Table

Overall Gain

All numbers in dB:

$-\infty$, -80.0, -75.0, -70.0, -65.0, -60.0, -55.0, -50.0, -45.0, -40.0, -35.0, -30.0, -28.0, -26.0, -24.0, -22.0, -20.0, -18.0, -16.0, -14.0, -12.0, -10.0, -9.5, -9.0, -8.5, -8.0, -7.5, -7.0, -6.5, -6.0, -5.8, -5.6, -5.4, -5.2, -5.0, -4.8, -4.6, -4.4, -4.2, -4.0, -3.8, -3.6, -3.4, -3.2, -3.0, -2.9, -2.8, -2.7, -2.6, -2.5, -2.4, -2.3, -2.2, -2.1, -2.0, -1.9, -1.8, -1.7, -1.6, -1.5, -1.4, -1.3, -1.2, -1.1, -1.0, -0.9, -0.8, -0.7, -0.6, -0.5, -0.4, -0.3, -0.2, -0.1, 0.0, 0.1, 0.2, 0.3, 0.4, 0.5, 0.6, 0.7, 0.8, 0.9, 1.0, 1.1, 1.2, 1.3, 1.4, 1.5, 1.6, 1.7, 1.8, 1.9, 2.0, 2.1, 2.2, 2.3, 2.4, 2.5, 2.6, 2.7, 2.8, 2.9, 3.0, 3.2, 3.4, 3.6, 3.8, 4.0, 4.2, 4.4, 4.6, 4.8, 5.0, 5.2, 5.4, 5.6, 5.8, 6.0, 6.5, 7.0, 7.5, 8.0, 8.5, 9.0, 9.5, 10.0

Bandwidth

All numbers are fractions of octaves:

$1/6$, $1/3$, $1/2$, $2/3$, $5/6$, 1, $11/6$, $1\ 1/3$, $1\ 1/2$, $1\ 2/3$, $1\ 5/6$, 2, $2\ 1/6$, $2\ 1/3$, $2\ 1/2$, $2\ 2/3$, $2\ 5/6$, 3, $3\ 1/6$, $3\ 1/3$, $3\ 1/2$, $3\ 2/3$, $3\ 5/6$, 4, $4\ 1/6$, $4\ 1/3$, $4\ 1/2$, $4\ 2/3$, $4\ 5/6$, 5, $5\ 1/6$, $5\ 1/3$, $5\ 1/2$, $5\ 2/3$, $5\ 5/6$, 6, $6\ 1/6$, $6\ 1/3$, $6\ 1/2$, $6\ 2/3$, $6\ 5/6$, 7, $7\ 1/6$, $7\ 1/3$, $7\ 1/2$, $7\ 2/3$, $7\ 5/6$, 8.

Frequency

All numbers are Hertz and are either center or cutoff frequency:

41, 44, 46, 49, 52, 55, 58, 62, 65, 69, 73, 78, 82, 87, 92, 98, 104, 110, 117, 123, 131, 139, 147, 156, 165, 175, 185, 196, 208, 220, 277, 294, 311, 330, 349, 370, 392, 415, 440, 466, 494, 523, 554, 587, 622, 659, 698, 740, 784, 831, 880, 932, 988, 1050, 1110, 1170, 1240, 1320, 1400, 1480, 1570, 1660, 1760, 1860, 1980, 2090, 2220, 2350, 2490, 2640, 2790, 2960, 3140, 3320, 3520, 3730, 3950, 4190, 4430, 4700, 4980, 5270, 5590, 5920, 6270, 6640, 7040, 7460, 7900, 8370, 8870, 9400, 9960, 10500, 11200, 11800, 12500, 13300, 14100, 14900, 15800, 16700, 17700

Attack, Release Delay, Release Fast & Slow, Average, RMS, Preview (when applicable):

All numbers are in seconds:

20 μ , 40 μ , 60 μ , 80 μ , 100 μ , 125 μ , 160 μ , 200 μ , 250 μ , 315 μ , 400 μ , 500 μ , 630 μ , 800 μ , 1m, 1.25m, 1.60m, 2.00m, 2.50m, 3.15m, 4.00m, 5.00m, 6.30m, 8.00m, 10.0m, 12.5m, 16.0m, 20.0m, 25.0m, 31.5m, 40.0m, 50.0m, 63.0m, 80.0m, 100m, 125m, 160m, 200m, 250m, 315m, 400m, 500m, 630m, 800m, 1, 1.25, 1.60, 2.00, 2.50, 3.15, 4.00, 5.00, 6.30, 8.00

$\mu = 10^{-6}$

m = 10^{-3}

Soft-knee:

0.0, 0.1, 0.2, 0.3, 0.4, 0.5, 0.6, 0.7, 0.8, 0.9, 1.0

Threshold:

All numbers are in dB:

0, -1, -2, -3, -4, -5, -6, -7, -8, -9, -10, -11, -12, -13, -14, -15, -16, -17, -18, -19, -20, -21, -22, -23, -24, -25, -26, -27, -28, -29, -30, -31, -32, -33, -34, -35, -36, -37, -38, -39, -40, -41, -42, -43, -44, -45, -46, -47, -48, -49, -50, -51, -52, -53, -54, -55, -56, -57, -58, -59, -60

Ratio:

1:5.00, 1:4.95, 1:4.90, 1:4.85, 1:4.80, 1:4.75, 1:4.70, 1:4.65, 1:4.60, 1:4.55, 1:4.50, 1:4.45, 1:4.40, 1:4.35, 1:4.30, 1:4.25, 1:4.20, 1:4.15, 1:4.10, 1:4.05, 1:4.00, 1:3.95, 1:3.90, 1:3.85, 1:3.80, 1:3.75, 1:3.70, 1:3.65, 1:3.60, 1:3.55, 1:3.50, 1:3.45, 1:3.40, 1:3.35, 1:3.30, 1:3.25, 1:3.20, 1:3.15, 1:3.10, 1:3.05, 1:3.00, 1:2.95, 1:2.90, 1:2.85, 1:2.80, 1:2.75, 1:2.70, 1:2.65, 1:2.60, 1:2.55, 1:2.50, 1:2.45, 1:2.40, 1:2.35, 1:2.30, 1:2.25, 1:2.20, 1:2.15, 1:2.10, 1:2.05, 1:2.00, 1:1.95, 1:1.90, 1:1.85, 1:1.80, 1:1.75, 1:1.70, 1:1.65, 1:1.60, 1:1.55, 1:1.50, 1:1.45, 1:1.40, 1:1.35, 1:1.30, 1:1.29, 1:1.28, 1:1.27, 1:1.26, 1:1.25, 1:1.24, 1:1.23, 1:1.22, 1:1.21, 1:1.20, 1:1.19, 1:1.18, 1:1.17, 1:1.16, 1:1.15, 1:1.14, 1:1.13, 1:1.12, 1:1.11, 1:1.10, 1:1.09, 1:1.08, 1:1.07, 1:1.06, 1:1.05, 1:1.04, 1:1.03, 1:1.02, 1:1.01, 1 : 1, 1.05:1, 1.11:1, 1.17:1, 1.25:1, 1.33:1, 1.43:1, 1.54:1, 1.67:1, 1.81:1, 2.00:1, 2.22:1, 2.50:1, 2.86:1, 3.33:1, 4.00:1, 5.00:1, 6.66:1, 10.0:1, 20.0:1, 1000:1

Gain Makeup:

Scale is symmetrical around 0.0, only positive values listed. All numbers are in dB:

0.0, 0.2, 0.4, 0.6, 0.8, 1.0, 1.2, 1.4, 1.6, 1.8, 2.0, 2.2, 2.4, 2.6, 2.8, 3.0, 3.2, 3.4, 3.6, 3.8, 4.0, 4.2, 4.4, 4.6, 4.8, 5.0, 5.2, 5.4, 5.6, 5.8, 6.0, 6.5, 7.0, 7.5, 8.0, 8.5, 9.0, 9.5, 10.0, 10.5, 11.0, 12.0, 13.0, 14.0, 15.0, 16.0, 17.0, 18.0, 19.0, 20.0, 22.0, 24.0, 26.0, 28.0, 30.0, 32.0, 34.0, 36.0, 38.0, 40.0, 45.0, 50.0, 55.0, 60.0

off, max.

RMS time:

All numbers are in seconds:

40 μ , 60 μ , 80 μ , 100 μ , 125 μ , 160 μ , 200 μ , 250 μ , 315 μ , 400 μ , 500 μ , 630 μ , 800 μ , 1m, 1.25m, 1.60m, 2.00m, 2.50m, 3.15m, 4.00m, 5.00m, 6.30m, 8.00m, 10.0m, 12.5m, 16.0m, 20.0m, 25.0m, 31.5m, 40.0m, 50.0m, 63.0m, 80.0m, 100m, 125m, 160m, 200m, 250m, 315m, 400m, 500m.

$\mu = 10^{-6}$, m = 10^{-3}

Dither

Dithering algorithm is implemented using the POW-R set of algorithms. Graph 36 shows the three algorithms at 44.1kHz and 88.2kHz sampling rates each.

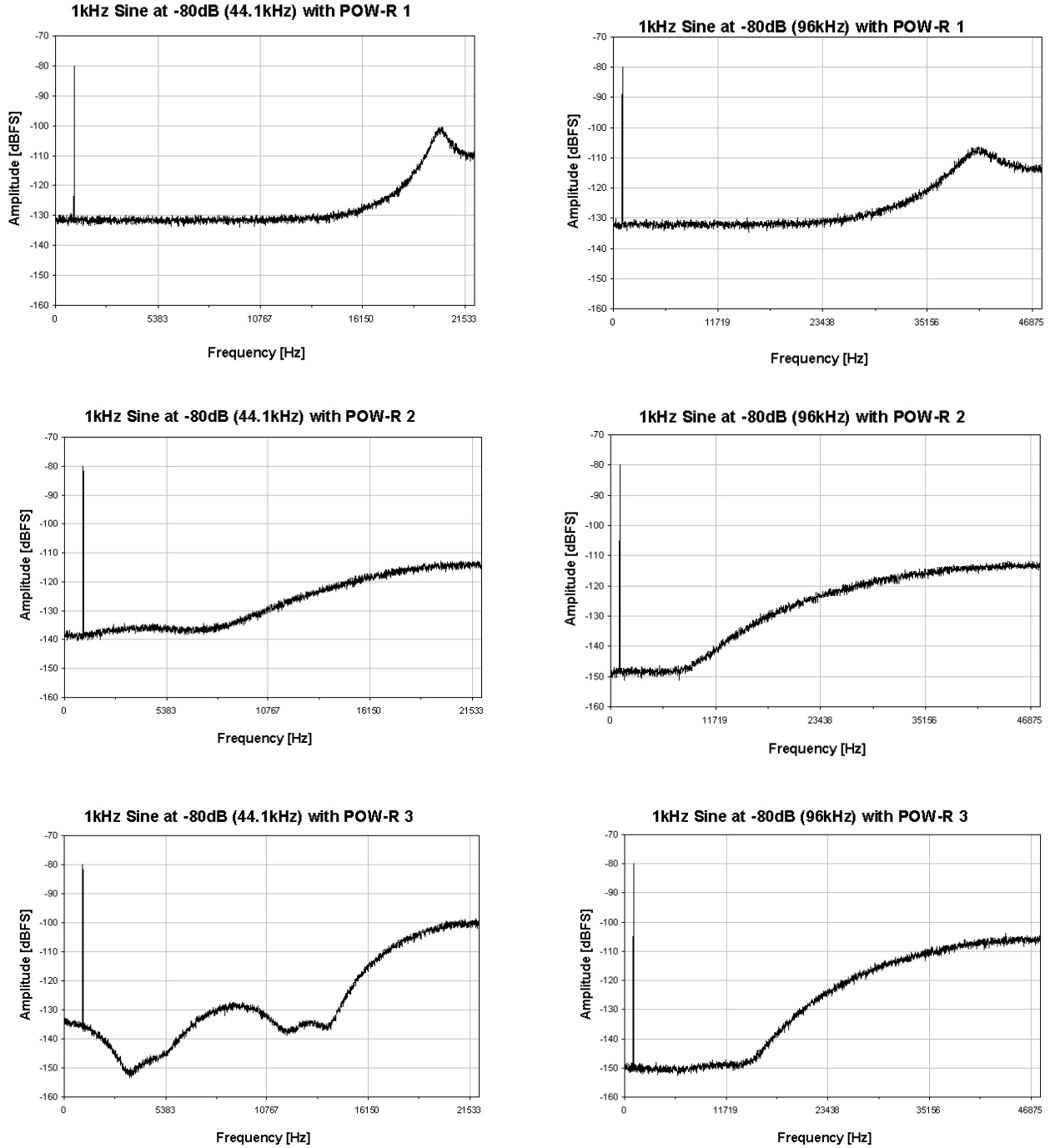

Graph 36: Output spectrum with 80dBFS / 1kHz sine wave, dithered to 16 Bits, using the three POW-R algorithms at 44.1kHz and 88.2kHz respectively

Remote

MIDI Implementation

System Inclusive

All band parameters plus the controls parameters are remote controllable. Each parameter has its corresponding MIDI controller number.

According to the different parameters, the controllers are limited in their range. Invalid values are replaced by the maximum allowable value. Following is a list of the supported MIDI commands:

Action	MIDI Message	Status Byte	Data Byte(s)	Comment
Restore Snapshot	Program Change	1100 cccc	0ppp pppp	(cccc) Channel No. (ppppppp) New Prog No: 0 - 127
Center Frequency 1	Control Change	1011 cccc	00000000 (\$00) 0vvv vvvv	(cccc) Channel No. (vvvvvvv) New Value: 0 - 105
Bandwidth 1	Control Change	1011 cccc	00000001(\$01) 0vvv vvvv	(cccc) Channel No. (vvvvvvv) New Value: 0 - 48
Filter Mode 1	Control Change	1011 cccc	00000010 (\$02) 0vvv vvvv	(cccc) Channel No. (vvvvvvv) New Value: 0= limiter, 1= Bandpass, 2 = Lowpass, 3 = Hipass
Preview Delay 1	Control Change	1011 cccc	00000011 (\$03) 0vvv vvvv	(cccc) Channel No. (vvvvvvv) New Value: 0 - 32
Attack 1	Control Change	1011 cccc	00000100 (\$04) 0vvv vvvv	(cccc) Channel No. (vvvvvvv) New Value: 0 - 43
Release Delay 1	Control Change	1011 cccc	00000101 (\$05) 0vvv vvvv	(cccc) Channel No. (vvvvvvv) New Value: 0 - 53
Release Fast 1	Control Change	1011 cccc	00000110 (\$06) 0vvv vvvv	(cccc) Channel No. (vvvvvvv) New Value: 0 - 53
Average 1	Control Change	1011 cccc	00000111 (\$07) 0vvv vvvv	(cccc) Channel No. (vvvvvvv) New Value: 0 - 53
Release Slow 1	Control Change	1011 cccc	00001000 (\$08) 0vvv vvvv	(cccc) Channel No. (vvvvvvv) New Value: 0 - 53
Soft Knee 1	Control Change	1011 cccc	00001001 (\$09) 0vvv vvvv	(cccc) Channel No. (vvvvvvv) New Value: 0 - 10
Gain Makeup Mode 1	Control Change	1011 cccc	00001010 (\$0A) 0vvv vvvv	(cccc) Channel No. (vvvvvvv) New Value: 0= off, 1 = manual, 2= maximum

Ratio 1	Control Change	1011 cccc	00001011 (\$0B) 0vvv vvvv	(cccc) Channel No. (vvvvvvv) New Value: 0 - 124
Threshold 1	Control Change	1011 cccc	00001100 (\$0C) 0vvv vvvv	(cccc) Channel No. (vvvvvvv) New Value: 0 - 60
Gain Makeup 1	Control Change	1011 cccc	00001101 (\$0D) 0vvv vvvv	(cccc) Channel No. (vvvvvvv) New Value: 0 - 126
Gain 1	Control Change	1011 cccc	00001110 (\$0E) 0vvv vvvv	(cccc) Channel No. (vvvvvvv) New Value: 0 - 127
Output Gain 1	Control Change	1011 cccc	00001111 (\$0F) 0vvv vvvv	(cccc) Channel No. (vvvvvvv) New Value: 0 - 127
Parallel Mode 1	Control Change	1011 cccc	00010000 (\$10) 0vvv vvvv	(cccc) Channel No. (vvvvvvv) New Value: 0 - 1
RMS time 1	Control Change	1011 cccc	00010000 (\$11) 0vvv vvvv	(cccc) Channel No. (vvvvvvv) New Value: 0 - 41
Center Frequency 2	Control Change	1011 cccc	00000000 (\$12) 0vvv vvvv	(cccc) Channel No. (vvvvvvv) New Value: 0 - 105
Bandwidth 2	Control Change	1011 cccc	00000001(\$13) 0vvv vvvv	(cccc) Channel No. (vvvvvvv) New Value: 0 - 48
Filter Mode 2	Control Change	1011 cccc	00000010 (\$14) 0vvv vvvv	(cccc) Channel No. (vvvvvvv) New Value: 0= limiter, 1= Bandpass, 2 = Lowpass, 3 = Hipass
Preview Delay 2	Control Change	1011 cccc	00000011 (\$15) 0vvv vvvv	(cccc) Channel No. (vvvvvvv) New Value: 0 - 32
Attack 2	Control Change	1011 cccc	00000100 (\$16) 0vvv vvvv	(cccc) Channel No. (vvvvvvv) New Value: 0 - 43
Release Delay 2	Control Change	1011 cccc	00000101 (\$17) 0vvv vvvv	(cccc) Channel No. (vvvvvvv) New Value: 0 - 53
Release Fast 2	Control Change	1011 cccc	00000110 (\$18) 0vvv vvvv	(cccc) Channel No. (vvvvvvv) New Value: 0 - 53
Average 2	Control Change	1011 cccc	00000111 (\$19) 0vvv vvvv	(cccc) Channel No. (vvvvvvv) New Value: 0 - 53
Release Slow 2	Control Change	1011 cccc	00001000 (\$1A) 0vvv vvvv	(cccc) Channel No. (vvvvvvv) New Value: 0 - 53

Soft Knee 2	Control Change	1011 cccc	00001001 (\$1B) 0vvv vvvv	(cccc) Channel No. (vvvvvvv) New Value: 0 - 10
Gain Makeup Mode 2	Control Change	1011 cccc	00001010 (\$1C) 0vvv vvvv	(cccc) Channel No. (vvvvvvv) New Value: 0= off, 1 = manual, 2= maximum
Ratio 2	Control Change	1011 cccc	00001011 (\$1D) 0vvv vvvv	(cccc) Channel No. (vvvvvvv) New Value: 0 - 124
Threshold 2	Control Change	1011 cccc	00001100 (\$1E) 0vvv vvvv	(cccc) Channel No. (vvvvvvv) New Value: 0 - 60
Gain Makeup 2	Control Change	1011 cccc	00001101 (\$1F) 0vvv vvvv	(cccc) Channel No. (vvvvvvv) New Value: 0 - 126
Gain 2	Control Change	1011 cccc	00001110 (\$20) 0vvv vvvv	(cccc) Channel No. (vvvvvvv) New Value: 0 - 127
Output Gain 2	Control Change	1011 cccc	00001111 (\$21) 0vvv vvvv	(cccc) Channel No. (vvvvvvv) New Value: 0 - 127
Parallel Mode 2	Control Change	1011 cccc	00010000 (\$22) 0vvv vvvv	(cccc) Channel No. (vvvvvvv) New Value: 0 - 1
RMS time 2	Control Change	1011 cccc	00010000 (\$23) 0vvv vvvv	(cccc) Channel No. (vvvvvvv) New Value: 0 - 41
Safety Limiter	Control Change	1011 cccc	00010000 (\$24) 0vvv vvvv	(cccc) Channel No. (vvvvvvv) New Value: 0 - 1
M/S Mode	Control Change	1011 cccc	00010000 (\$25) 0vvv vvvv	(cccc) Channel No. (vvvvvvv) New Value: 0 - 1
CH number	Control Change	1011 cccc	00010000 (\$26) 0vvv vvvv	(cccc) Channel No. (vvvvvvv) New Value: 0 - 1
Ganged	Control Change	1011 cccc	00010000 (\$27) 0vvv vvvv	(cccc) Channel No. (vvvvvvv) New Value: 0 - 1
Sidechain Link	Control Change	1011 cccc	00010000 (\$28) 0vvv vvvv	(cccc) Channel No. (vvvvvvv) New Value: 0 - 1
Bypass	Control Change	1011 cccc	00010010 (\$29) 0vvv vvvv	(cccc) Channel No. (vvvvvvv) New Value: 0= off, 1 = on
A-B Select	Control Change	1011 cccc	00010011 (\$2A) 0vvv vvvv	(cccc) Channel No. (vvvvvvv) New Value: 0= WS A, 1 = WS B

Monitor	Control Change	1011 cccc	00010100 (\$2B) 0vvv vvvv	(cccc) Channel No. (vvvvvvv) New Value: 0= off, 1 = on
System Reset		1111 1111	-	Recall Snapshot 0 to WS A

System Exclusive

Snapshot format:

Bytecount	Value	Description	
1	F0	Sysex	Header
2	00	Manufacturer's ID	
3	30	Manufacturer's ID	
4	5A	Manufacturer's ID	
5	08	Model ID: \$0C = Gambit DS1-MK3	
6	0000nnnn	Device ID: -> Midi channel number	
7	00000001	message = Snapshot dump	Message Type 1
8	0nnnnnnn	Package number (0..7F)	Data
9	0nnnnnnn	scale set number	
10 - 24	0nnnnnnn	15 Bytes of Snapshot data	
25	0ccccccc	Checksum without byte one (F0 Sysex Command)	Checksum
26	F7	EOS	EOS

Dump request:

Bytecount	Value	Description	
1	F0	Sysex	Header
2	00	Manufacturer's ID	
3	30	Manufacturer's ID	
4	5A	Manufacturer's ID	
5	08	Model ID: \$0C = Gambit DS1-MK3	
6	0000nnnn	Device ID: -> Midi channel number	
7	00000010	message = dump request	Message Type 2
8	F7	EOS	EOS

Version request:

Bytecount	Value	Description	
1	F0	Sysex	Header
2	00	Manufacturer's ID	
3	30	Manufacturer's ID	
4	5A	Manufacturer's ID	
5	08	Model ID: \$0C = Gambit DS1-MK3	
6	0000nnnn	Device ID: -> Midi channel number	
7	00000011	message = version request	Message Type 3
8	F7	EOS	EOS

Version send:

Bytecount	Value	Description	
1	F0	Sysex	Header
2	00	Manufacturer's ID	
3	30	Manufacturer's ID	
4	5A	Manufacturer's ID	
5	08	Model ID: \$0C = Gambit DS1-MK3	
6	0000nnnn	Device ID: -> Midi channel number	
7	00000100	message = send version	Message Type 4
8	00000100	OS Version	data
9	00000100	DSP Version	
10	00000100	Scale Version	
11	00000100	Coeff. Version	
12	F7	EOS	EOS

PC programming mode:

Bytecount	Value	Description	
1	F0	Sysex	Header
2	00	Manufacturer's ID	
3	30	Manufacturer's ID	
4	5A	Manufacturer's ID	
5	08	Model ID: \$0C = Gambit DS1-MK3	
6	0000nnnn	Device ID: -> Midi channel number	
7	00000101	message = pc programming mode	Message Type 5
12	F7	EOS	EOS

Addendum to the Manuals of the Gambit Series DS1, DS1-MK2 and DS1-MK3 DeEsser / Compressor / Limiter

The graphs on the pages below have been made to convey a better understanding of the dynamic parameters of the Gambit DS1 DeEsser/Compressor.

Please also read the appropriate pages in the DS1/DS1-MK2/DS1-MK3 manual to have a proper understanding of the sidechain process.

The test signal is a repeating sine wave burst with a certain "on" and a certain "off" level. The frequency of the sine wave is above 10kHz (period less than 100 μ s), so there is no influence of the sine wave frequency on the timing behaviour.

The table below shows the timing parameters set on the DS1. For the static parameters a threshold of -20dB, a 1000:1 ratio and no softknee have been chosen. The peak / RMS time parameter was set to peak measurement.

Figure	Preview	Attack	Rel.Delay	Rel.Fast	Average	Rel.Slow	burst duty cycle
1	bypass						
2	20 μ s	20ms	20 μ s	200ms	800ms	1s	50%
3	63ms	"	"	"	"	"	"
4	"	"	"	"	"	200ms	"
5	"	"	5ms	"	"	"	"
6	"	"	20ms	"	"	"	"
7	"	"	"	25ms	"	500ms	0.5%
8	"	"	"	"	"	"	2%
9	"	"	"	"	"	"	5%
10	"	"	"	"	"	"	10%
11	"	"	"	"	40ms	"	0.5%
12	"	"	"	"	"	"	2%
13	"	"	"	"	"	"	5%
14	"	"	"	"	"	"	10%

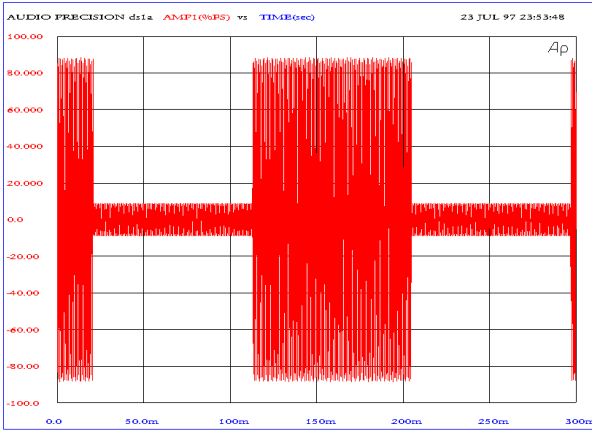

Fig. 1

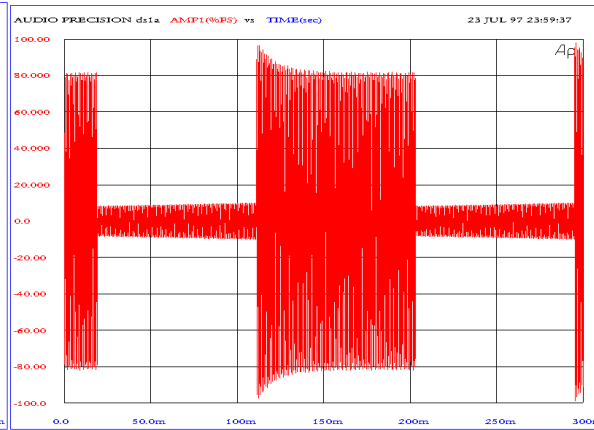

Fig. 2

Fig. 1 Bypass, this is how the 50% dutycycle sinewave burst looks like. X-axis shows time in milliseconds, Y-axis shows linear level in percentage of full scale. Just like a scope.

Fig. 2 A very short preview time combined with a long attack time cause an overshoot at the onstart of the burst. As the sidechain reacts to the input signal (slowly because of the long attack time) the level of the burst is brought to the anticipated level.

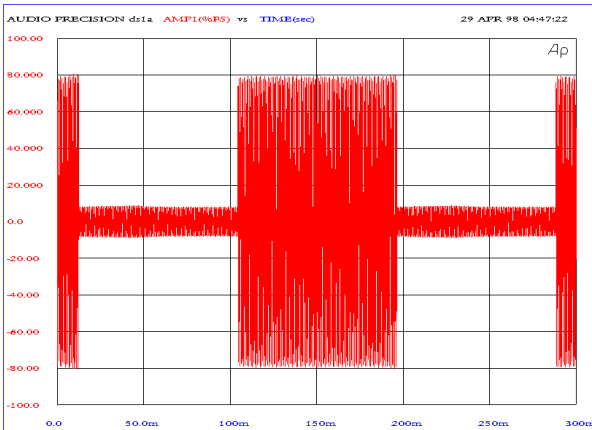

Fig. 3

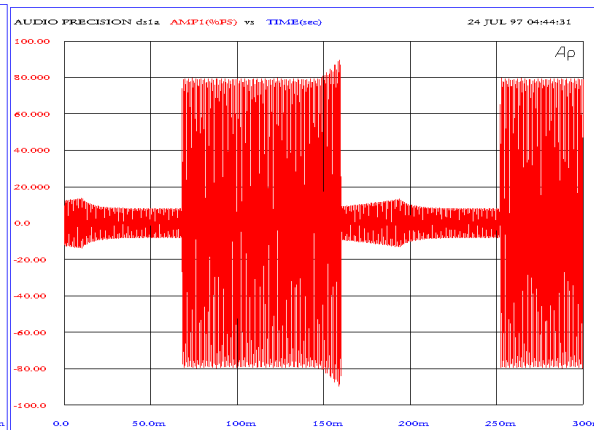

Fig. 4

Fig. 3 The preview time is now about three times the attack time, which gives the sidechain a headstart on the audio signal. The result is a proper limiting without overshoot.

Fig. 4 As useful the preview facility in Fig 3 is, it can have an unwanted effect at the release portion. A relatively short release time causes the release to show up during the last milliseconds of the burst. This because the sidechain "sees" the "burst off" before the gain stage sees it (preview delay), so the end of the burst gets influenced by the release.

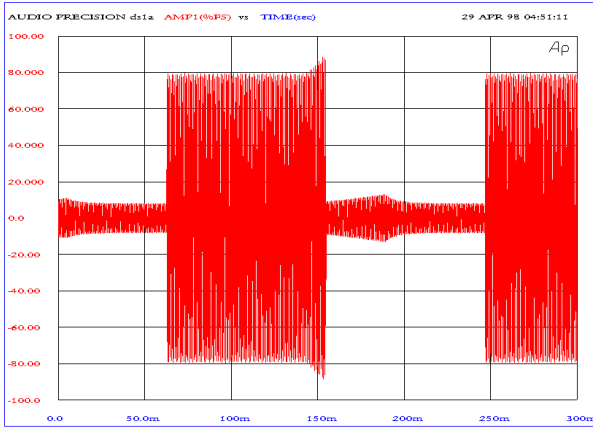

Fig. 5

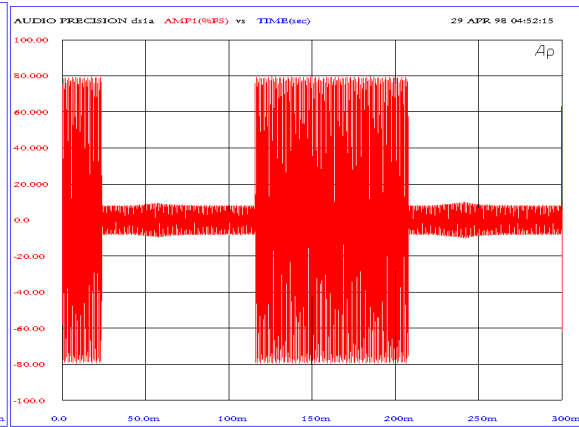

Fig. 6

Figs. 5 and 6 The effect described in Fig. 4 can be eliminated with the Release Delay parameter. The release is delayed for a certain time and thus can not influence the end of the burst anymore. In Fig 5 the release delay is not quite long enough, while in Fig. 6 there is no release influence visible anymore.

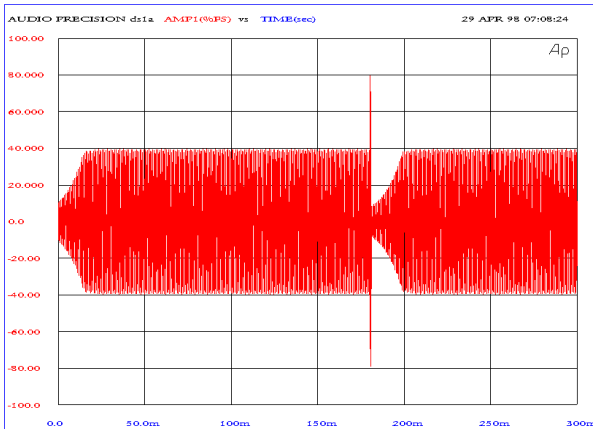

Fig. 7

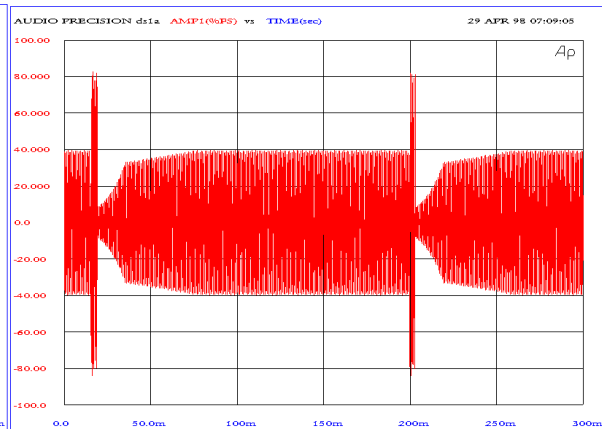

Fig. 8

The following figures show the effect of the automatic release time algorithm and the Average parameter.

Fig. 7 A very short burst duration, like a short peak in the music. The Release Fast, Average and Release Slow parameters are set to typical values. Fig. 7 shows that after a short peak the Release Fast time is chosen, so that the short peak does not have much influence on the programme after it.

Fig. 8 The burst is now longer which gives it more influence on the average measurement (averaging off the signal). First there is a Release Fast portion followed by a short segment of Release Slow.

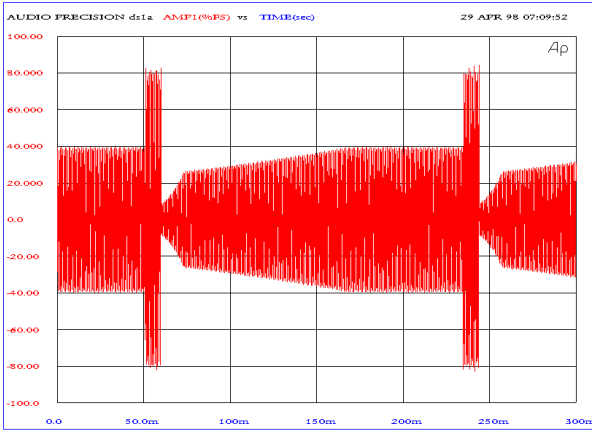

Fig. 9

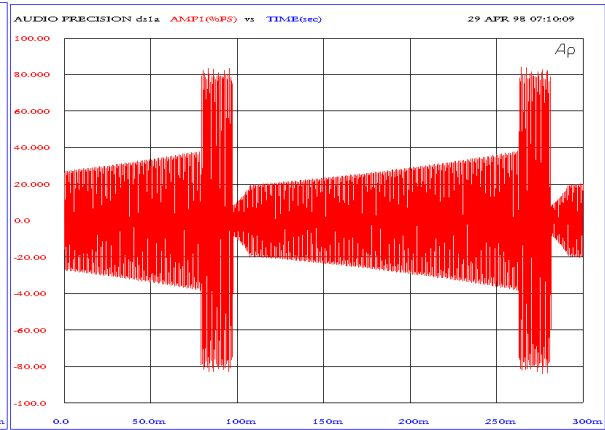

Fig. 10

Fig. 9 The burst is even longer, causing a longer Release Slow portion.

Fig. 10 Still longer burst, with even longer Release Slow portion.

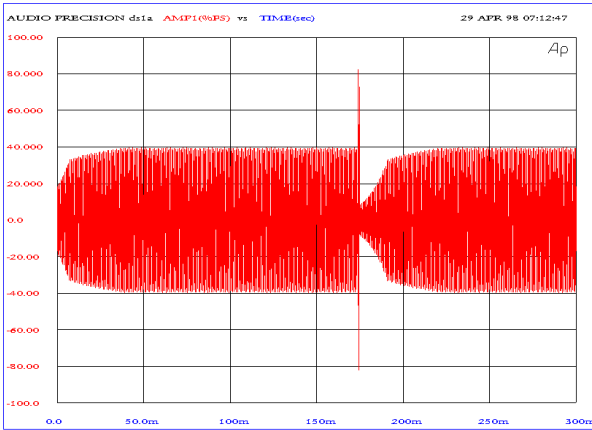

Fig. 11

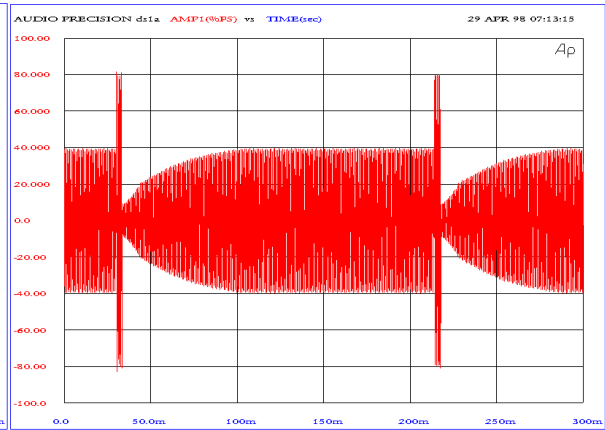

Fig. 12

Figs. 11 to 14 For these figures the Average time is relatively short, causing the average measurement value to follow the peak measurement more quickly than with Fig. 7 to 10. The effect is that depending on the burst length, there is not that much of an influence of the Release Slow parameter as it was with figures 7 to 10.

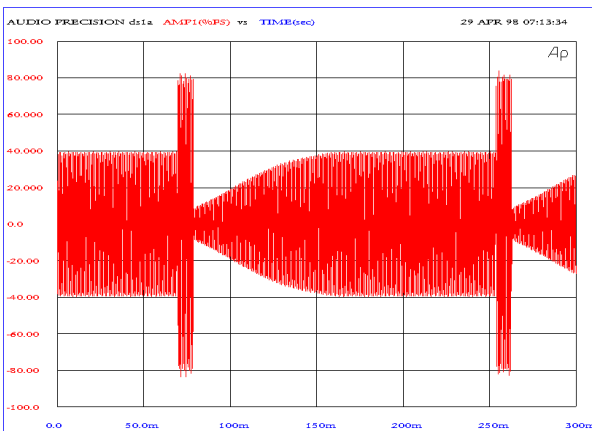

Fig. 13

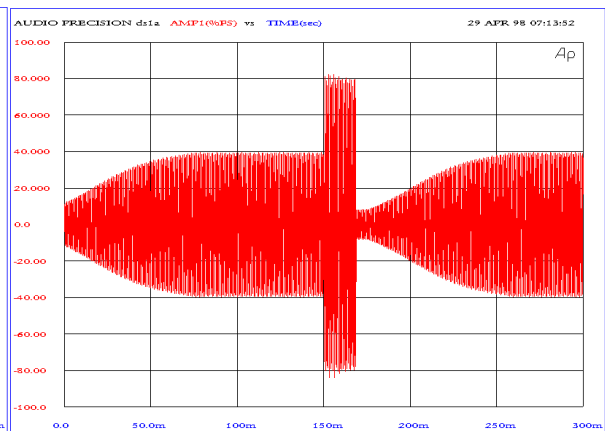

Fig. 14